

P1: M-065A

P2: M-042

Customer No.:

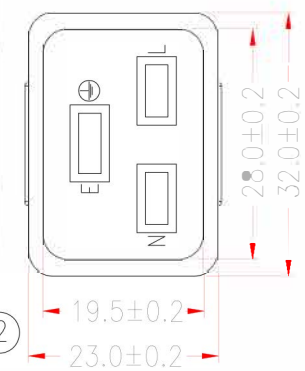
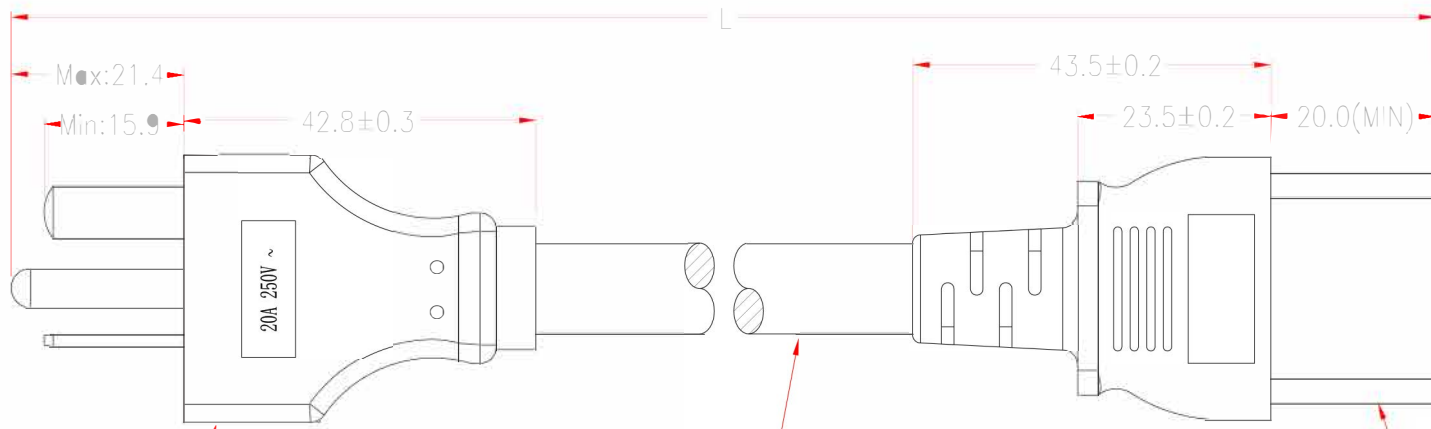
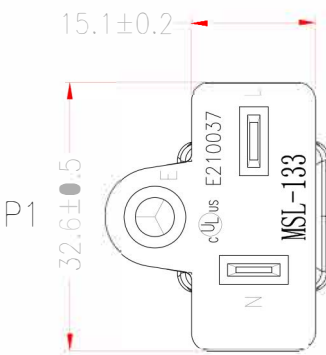

① NEMA 6-20P (MSL-133)

② EC 320 C19(MSL-119)

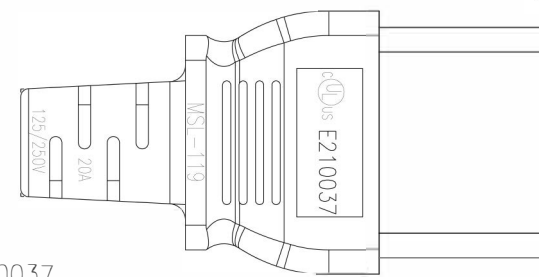
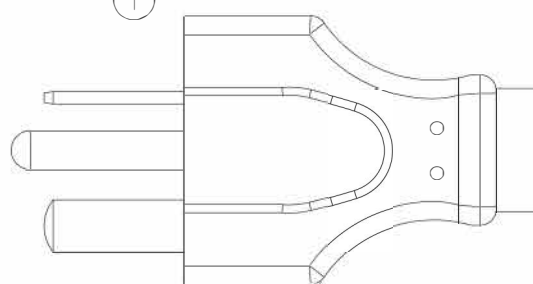

P1,P2: E210037

*NOTE: All relevant materials are complied with RoHS directive .

THE CABLE MARKING IS CONCAVE LETTERING MOULD

PACKING C: >2FT

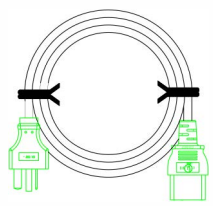

PACKING A: <1FT

PACKING B: <2FT

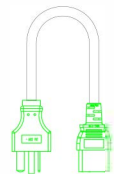
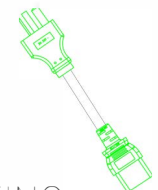

MARKING:

(UL) SJT 3/C 12AWG(3.31MM²) VW-1 105°C 300V E204978
 CSA SJT 3/C 3.31MM²(12AWG) FT2 105°C 300V 204790 MSL

ITEM NO.	LENGTH(L)	LENGTH(X)
10W1-620C19-03	915mm	885mm
10W1-620C19-06	1830mm	1800mm
10W1-620C19-08	2440mm	2410mm
10W1-620C19-10	3050mm	3020mm
10W1-620C19-15	4570mm	4540mm

	P1	P2
BLACK	L _____	L _____
WHITE	N _____	N _____
GREEN	E _____	E _____

3	UL SJT 12AWG x 3C, OD 11.0mm, JACKET BLACK, DRAWING No. EPSJT011203C-158	H5TC41-0304K09	Xmm	M304
	MOLDED PVC 35P, COLOR BLACK	H1BC02-0304K09		M304
2	BRACKET: YST-037	A1QC36-0767K09	1	M767
	TERMINAL: 98739ABS-0	A1QB33-0257	3	M257
1	MOLDED PVC 35P, COLOR BLACK	H1BC02-0304K09		M304
	BRACKET: CP-R423G-BS(MSL-133)	A1QC64-0767	1	M767
	TERMINAL: 98695L	A1QB37-0257	2	M257
	TERMINAL: φ4.75mm 98473	A1QB46-0257	1	M257

No.	DESCRIPTION			Q'TY	Supplier
APPROVED					
CHECKED	HU	19/JAN/18	DRAWN NAME	POWER SUPPLY CORDS & CORDS SETS	
DRAWING	TANG	19/JAN/18	PRODUCT NO.	PWCD-620PC19-20A-XXF-BLK	

Cable Length Unless Other Spec.
 Tolerances:
 0 ~200mm ±10mm
 201~1000mm ±20mm
 1001~1500mm ±25mm
 1501~2100mm ±30mm
 2100mm↑ ±40mm

NOTE: Cable Length Unless Otherwise Spec. Tolerances: Under 6FT ±25mm; Another ±50mm

UNIT: mm